

 R I D E R  
ELECTRIC VEHICLES

PUSA45



USER'S MANUAL

---

---

ERIDER

Millesteenstraat 75, 8890 Dadizele  
[info@erider.be](mailto:info@erider.be)  
[www.erider.be](http://www.erider.be)

# WELCOME TO THE ELECTRIC REVOLUTION

---

Dear *PUSA45* owner:

Congratulations, you are now taking part of the *electric revolution* and from *Ecomobility Green World* we welcome you. The Twenty-First Century will be remembered as the biggest electrification process of urban mobility and this is only possible because of people like you, convinced of changing to a clean and sustainable riding.

The purpose of this manual is to help you understand your electric motorcycle and make the maintenance easier. We hardly recommend you to read that instructions to take the most of your motorbike in a safety way.

Hope you enjoy it!

**E R I D E R**  
ELECTRIC VEHICLES

e-Revolution



# CONTENTS TABLE

---

<a href="#">Introduction</a>	04
<a href="#">Safety driving</a>	05
<a href="#">Scooter identification</a>	07
<a href="#">First start</a>	08
<a href="#">Display</a>	09
<a href="#">Controls</a>	10
<a href="#">Acceleration and braking</a>	12
<a href="#">Efficiently driving</a>	13
<a href="#">Battery indicator</a>	14
<a href="#">Battery recharge</a>	16
<a href="#">Technical specifications</a>	18



# INTRODUCTION



Your PUSA45 is a electric scooter that will turn your daily life easier.  
You can drive it with your car license and you will never worry again about traffic jams, gas stations or parking.  
We call it **#instanttorque** and we think it is addictive!

General instructions before riding:

1) **Tire pressures:** Check the tires for correct inflation and for any signs of physical damage.

2) **Brake check:** Squeeze the brake lever (front and rear) as hard as you can, push the scooter forward and check the braking resistance.

3) **Safety Circuit Breaker:** It is a safety switch placed under the seat. It might be turned *OFF* when delivery and technical service, and it must be turned *ON* before riding.



This symbol informs you that exposure to high voltage can cause shock, burns and even death.

The high voltage components on the motorcycle should be serviced only by technicians with special training.

4) **Battery Check:** Make sure your scooter is sufficiently charged for your ride and always check the battery indicator while you are riding. Be sure that battery does not get too low too often. Sometimes the voltage meter on left side of dashboard would be more accurate than bars battery indicator, this is normal because of lithium battery properties. Always charge the battery before using and after every use. More frequently charging is better for battery life.

5) **Ready to ride:** Make sure the side stand is removed and the killswitch is in “GO” position before riding. If some of that sensors are not ready the scooter will not respond to the accelerator.

6) **Steering:** Check the handlebar for any damage. Squeeze the front brake and push the handlebar up and down to check for any unusual noise. Move the handlebar in all directions to check for any loose parts or obstructions. Any problems should be corrected before use.

7) **Suspension:** Check the correct working of the fork and the rear suspension before riding.

## 8) Safety notice:

8.1. **Key in “OFF”:** To avoid the scooter moving away unexpectedly, always turn the key to the “OFF” position before dismounting or leaving the scooter unattended.

8.2. **Rear brake:** Always engage the rear brake when mounting or dismounting the scooter. Ensure that you are seated on the scooter and check that the stands are clear of the ground before touching the throttle. If you twist the throttle before you are ready to go or while you are mounting the scooter it may move away from you and could lead to an accident.

9) **Water and cleaning:** Your scooter can be ridden in wet and rainy conditions. When riding in rain, do not ride through deep puddles or muddy areas as excessive water will cause the motor and other electrical components to suffer damage. During cleaning, as with any motor vehicle, be sure to avoid soaking any electrical component to avoid serious damage. Never use high pressure washer when cleaning the bike.

10) **Parking:** Your bike should not be left in strong, direct sunlight or heavy rain for extended periods of time as it will prematurely age and damage paintwork and the general finish of the scooters appearance and some of the electric components may overheat.

11) **Riding:** Never ride your bike overloaded. Prolonged use with excessive weight could cause serious damage to the electronic and mechanical parts and void your warranty. It is recommended that all new scooter riders enroll in motorbike riding training.

12) **Road rules:** As with any vehicle, a scooter rider must always comply with the local road traffic rules and regulations. Before taking your scooter out on a public road, make sure you are familiar with traffic rules and regulations and any special requirements for motorcycles & scooters.

13) **Never drink and ride:** Alcohol slows reflexes and greatly limits your ability to operate a scooter. Even a very small amount of alcohol will reduce your ability to operate a scooter safely.



# SCOOTER IDENTIFICATION



Frame VIN  
(under the box)

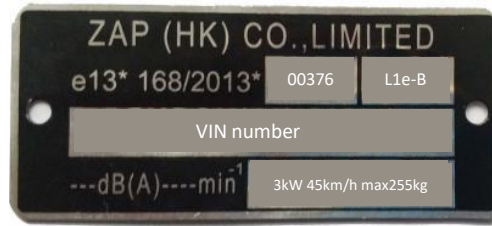

Identification Plate  
(side)

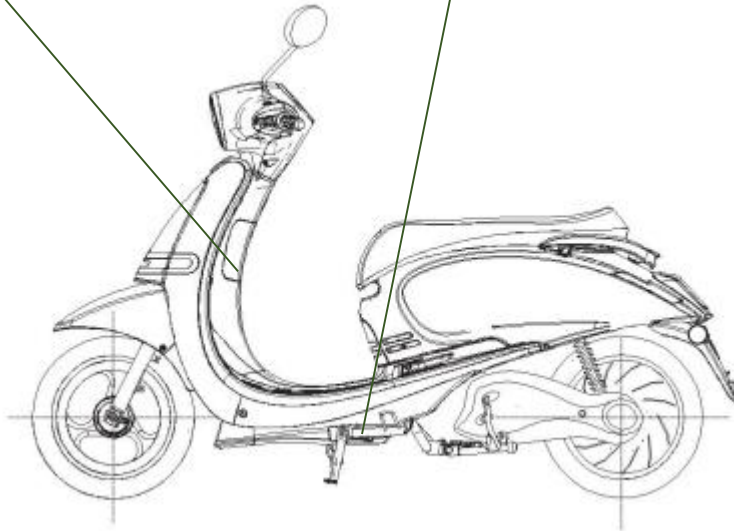

## Dealer information:

Name of the Dealer:

\_\_\_\_\_

Address of the Showroom:

\_\_\_\_\_

\_\_\_\_\_

Tlf: \_\_\_\_\_

E-mail:

\_\_\_\_\_

Invoice date: \_\_\_\_\_

## Scooter information:

Model:

**PUSA45**

VIN:

\_\_\_\_\_

# FIRST START

## SAFETY CIRCUIT BREAKER

The scooter includes a safety circuit breaker under the seat that disconnects all the electric system of the bike in case it detects an extreme overcurrent or overheat and it must be manually rearmed. It also allows a manual disconnection.



## KEY LOCK

The bike has 2 key locks:



Ignition and seat key lock



Steering box key lock

### KEY LOCK

OFF	Scooter is turned OFF. The key can be extracted in that position.
ON	Turn the key right. Scooter is turned ON. The key can not be extracted in that position.
LOCK	Press and turn the key left. Scooter is turned OFF and handlebar is locked. To avoid theft, turn the handlebar to the left and turn the key to the LOCK position.
OPEN	Turn the key left. It opens the seat lock.

The display displays the basic parameters for riding:

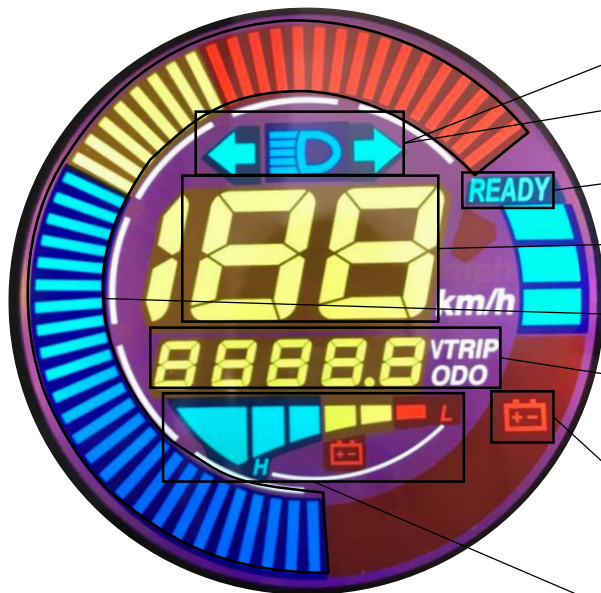



1. **Turning lights:** Right and left turning lights indicator LEDs
2. **High beam:** High beam indicator LED
3. **READY:** Indicates that the HV system is connected while 0km/h (ready to ride).
4. **Speed:** Indicates speed digitally measured in km/h (EU homologation).
5. **RPM level:** Indicates motor rpm speed graphically (direct drive).
6. **MULTIDATA:** Numeric data changes in intervals of 10 seconds.
  - i. **Trip meter (TRIP):** Measures ridden kilometers from last key ON.
  - ii. **Odometer (ODO):** Measures ridden kilometers from bike manufacturing.
  - iii. **Voltage (V):** Measures battery voltage.
7. **Low battery:** A warning when low battery.
8. **Battery level:** Battery estimated remaining capacity.

CONTROL	ACTION
High beam	Fixed light: Push the switch up
	Burst light: Push the button down
Turning signal switch	Right lights: Slide right Turn blinkers OFF: Push central button Left lights: Slide left
Claxon button	Sound the claxon: Push
Rear brake lever	The accelerator will be interrupted while any brake lever is pushed. The acceleration will start again when you release the brake lever and turns the throttle.  <i>Rear mechanical brake + Rear regenerative brake.</i>



# CONTROLS



CONTROL	ACTION
Throttle grip	Torque : Twisting the throttle grip
Reverse	Riding backwards: Press the Reverse button and twist the throttle to ride backwards.
Killswitch	Disables traction: Interruptor "OFF"  Enables traction: Interruptor "ON" 
Emergency	Turns ON all turning lights (emergency advise)
Front brake lever	The accelerator will be interrupted while any brake lever is pushed. The acceleration will start again when you release the brake lever and turns the throttle. <i>Front mechanical brake + Rear regenerative brake.</i>



# ACCELERATION AND BRAKING

## Acceleration tips:

1. Turn the key “ON” and check the killswitch is in “ON” position. Remove the side stand and then your bike will be ready to ride as soon as you twist the throttle.
2. Your scooter has a great acceleration capability. To avoid losing control you must twist the throttle slowly while speed increases gradually.
3. Don’t twist the throttle until you are ready to ride.
4. After braking, make sure you release the throttle, release the brake levers, and then twist the throttle again.
5. The electric brushless motor emits a magnetic slight noise when accelerating. It’s the silent revolution that’s coming.
6. For your safety, turn the key in “OFF” position while you are not riding.

## Deceleration tips:

1. To stop the bike, release the throttle and push the front and rear brakes simultaneously. Both brakes activates the reg. braking in addition to the mechanical disc brake.
2. For your safety, the scooter has a button on the brake lever. When you push front or rear brakes the motor controller disables the traction. Release the throttle during braking, and twist it smoothly after releasing the brake lever to accelerate again.

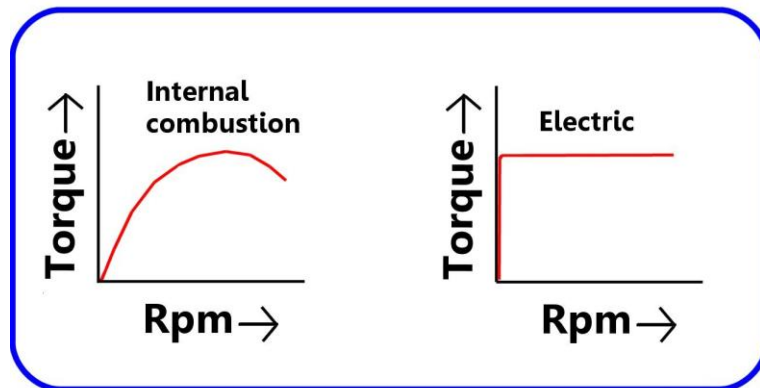

TORQUE = Acceleration capability  
(measured in Nm)

RPM = Revolutions per minute

¡Electric motors give instant torque from 0 rpm!

#instanttorque

# EFFICIENTLY DRIVING

## Tips for increasing efficiency (maximum range) :

1. Accelerate gradually and smoothly. Avoid quick unnecessary accelerations.
2. Avoid hard braking, try to anticipate to the brake necessity with time enough to stop the scooter by reg. braking when possible.
3. Release the throttle and ride free of energy consumption when possible.



## Factors that affects the efficiency

CONTROLLABLE	MAINTENANCE		DRIVING	
Maximize Autonomy	Filled tires	Strong bodywork	Calm driving	Reduced load
Reduce Autonomy	Deflated tires	Loose bodywork	Aggressive driving	Overload

EXTERNAL	ROUTE				WEATHER	
Maximize Autonomy	Slow speed	Plain road	Solid road surface	Minimum stops	Warm	Windless
Reduce Autonomy	High speed	Uphill and downhill	Bumps and sand surface	Several stops and starts	Very cold or very hot	Strong winds

# BATTERY INDICATOR

6 bars display



BARS INDICATOR	VOLTAGE	DESCRIPTION
6/6	More than 80V	Full battery
3/6	Less than 74V	Half battery
Less than 2/6	Less than 72V	Low battery



## LOW BATTERY:

Under 72V the controller will limit the output current to the motor, therefore the top speed will be reduced to save energy. If that happens, make sure the scooter has enough battery to reach an available plug.

*Some times voltage meter is more accurate than bars indicator.*

*Accelerating and reg. braking rises and lowers voltage.*

*Battery estimated state of charge (SoC) is more accurate after a few minutes with bike keyed OFF.*

# BATTERY INDICATOR

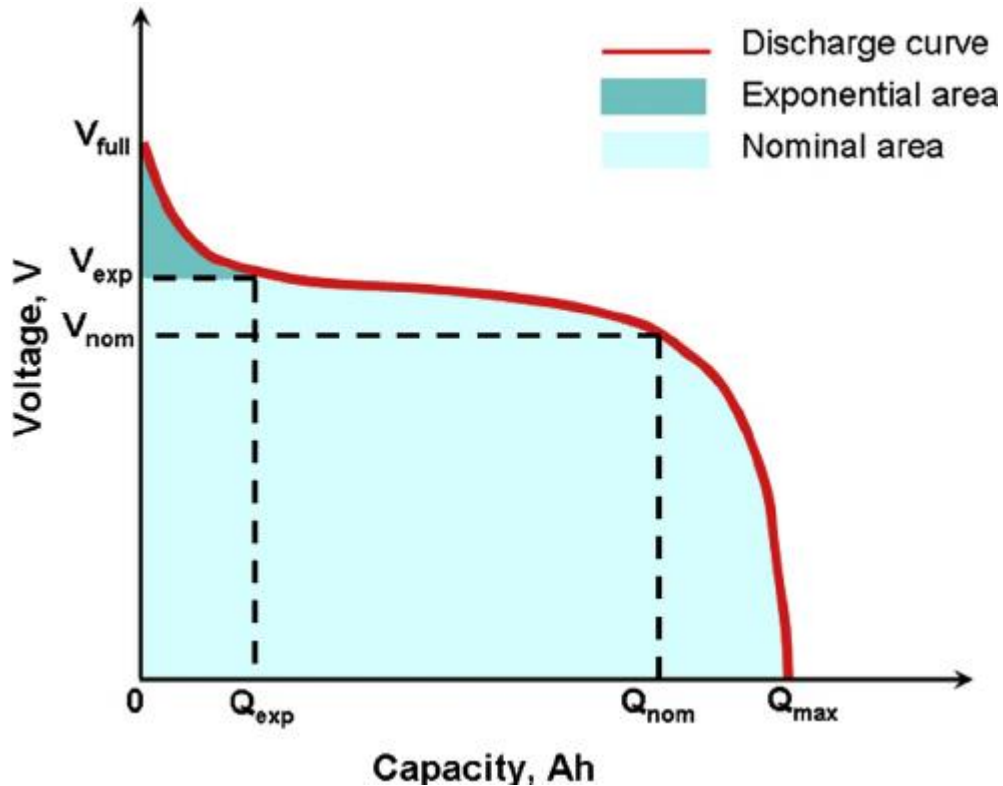

That's an example about how your battery gets discharged:

**1<sup>st</sup> stage: Exponential area. From 84V to 78V**  
You will notice that first run after charging will easily burn the first battery indicator bar. Don't worry, it won't be proportional!

**2<sup>nd</sup> stage: Nominal area. From 78V to 65V**  
Most of the time you will run in nominal area.

The scooter will stop working at about 65V as full discharge for safety reasons and battery longevity.

# BATTERY RECHARGE

- The battery must be charged through original external charger (AC-DC converter) for maximum longevity and to preserve warranty.

**NEVER PLUG THE BATTERY DIRECTLY TO THE GRID (AC).**

- Turn the circuit breaker disconnected while charging the battery connected to the controller.
- The charger connects to a conventional Schuko plug.
- Estimated charge time is 5h from 0 to 80%. Over 80% charge gets slower for battery longevity. Full charge may take about 8h.
- To maintain battery in optimum conservation, it is not recommended to discharge them under 30% if not necessary. We strongly recommend charging the battery before every use.
- The battery chemistry is NMC configured as 72V25Ah nominal (1.8kWh). 84V max.
- NMC batteries has no memory effect, therefore you don't need to full discharge it to achieve a good performance.
- The battery can be charged no matter the state of charge (SoC). Charging it frequently will increase battery lifespan.
- The temperature range for charging your battery is 0°C to +35°. Do not charge the battery under 0°C or over 35°C. Riding range is -15°C to +40°C.

Remember to keep the battery about 60% (76V) and cut off the circuit breaker when long periods of inactivity, and keep checking battery voltage every month if possible.

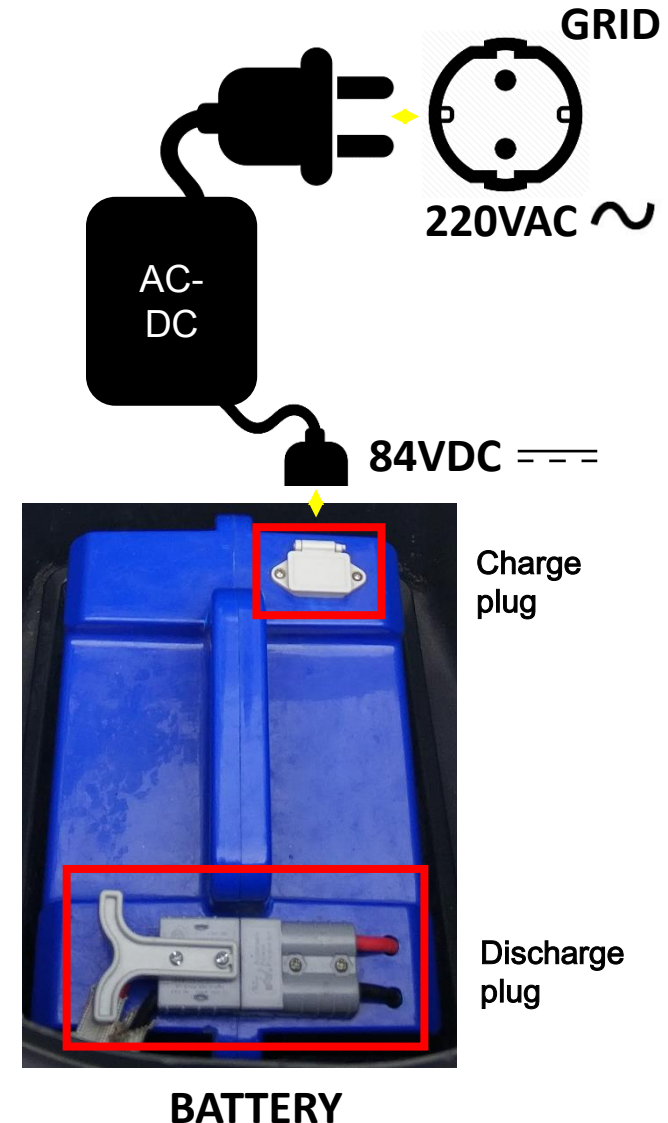



# MAINTENANCE GUIDE

The nucleus of the motorcycle is a electric propulsion system which doesn' t need any maintenance. Thanks to its 12" hub engine technology and to its air refrigeration system for the battery, engine, controller and charger, we can forget all the usual noises, vibrations and maintenance typical of combustion motorcycles.

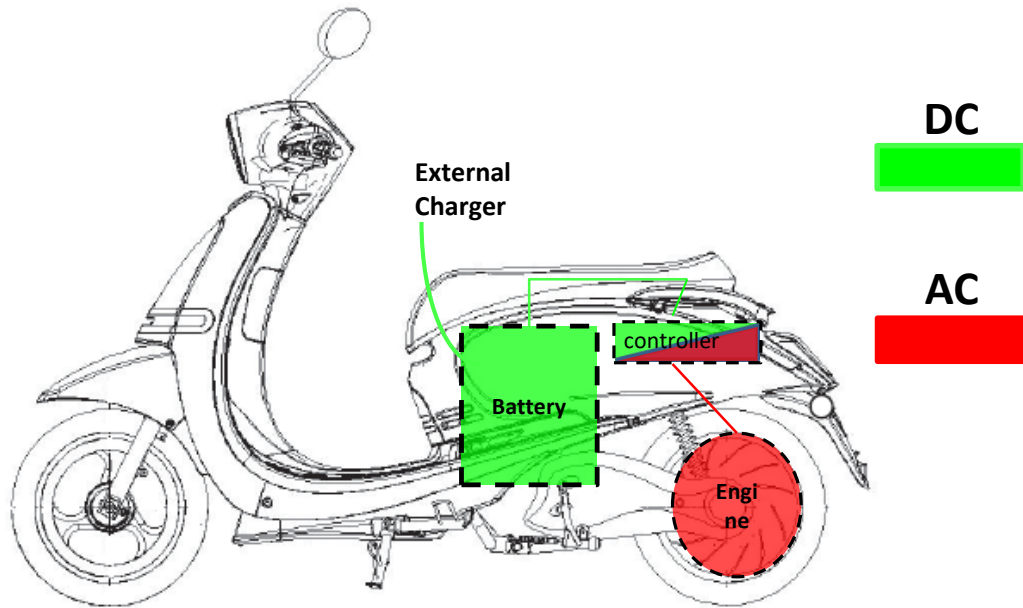

**FOR THE FIRST USERS OF AN ELECTRIC MOTORCYCLE:**  
 Due to the absence of noises and vibrations of the engine, while driving en electric motorcycle, you will perceive the noises and vibrations of the mechanical components, like tyre friction, headset chafing, disc and spark plug friction, etc.. And you' ll perceive as well the noises of road, This is normal and it doesn' t affect the correct functioning of the vehicle.

	Motor Oil
	Oil filter
	Spark plug
	Carburation

	Speed variator
	Drive belt
	Air filter
	Valve adjustment
	Coolant

# MAINTENANCE GUIDE

The maintenance of our scooter is simple and basic:

## Brakes:

- ✓ Check the liquid properties
- ✓ Check the pads and disc brake status
- ✓ Check the brake levers



## Tyres:

- ✓ Check the tyres pressure and status
- ✓ Check the axis and the bearings status

## Steering, fork, rear suspension and swingarm:

- ✓ Check the play and tightenings
- ✓ Check if there are leaks in the roadblocks
- ✓ Check suspensions junction to the chassis



## Other mechanisms to check preventively :

- ✓ Passenger footrest
- ✓ Ignition and seat key lock
- ✓ Locking system of the seat
- ✓ Side easel
- ✓ Central easel

# NECESSARY MAINTENANCE

FIRST CHECK	1.000km / 6 months
RECURRENT MAINTENANCE	6.000 km / 1 year

## Brakes liquid

DOT 3 o DOT 4

## Tyre pressure:

Medium cargo:

200 kPa front

230 kPa rear

Maximum cargo:

230 kPa front





250 kPa rear

**In summary:** Scooters must be checked at least every 6.000km or 1 year to perform a preventive maintenance of all common scooter components to keep it in optimal condition. That maintenance can be done in your trusted repair shop.

The maintenance can be carried out by your trusted mechanic. He just has to contact us in order to add him to our partners' network.

## Contact us:

[service@ecomobilitygreenworld.com](mailto:service@ecomobilitygreenworld.com)

	Brake fluid	6.000km / 1year → Check (Replace at least every 2 years)
	Brake pads	6.000km / 1years → Check (Replace if necessary)
	Tires pressure and condition	6.000km / 1years → Check (Replace if necessary)
	General lubrication	6.000km / 1year → Lubricate (Grease or oil depending on component)
	Bolts tight	6.000km / 1year → Check (Adjust if necessary)

# NECESSARY MAINTENANCE

## Headlight height:

The regulation bolt of the front headlight is situated behind the upper front cover of the scooter, in the upper part of the light bulb.

COMPONENT	REFERENCE
Headlight	1x 5W 12V
High/low beams	1x H4 12V
Front turnal lights	2x LED
Rear turnal lights	2x LED
Rear and brake light	LED
Number plate light	1x 5W 12V

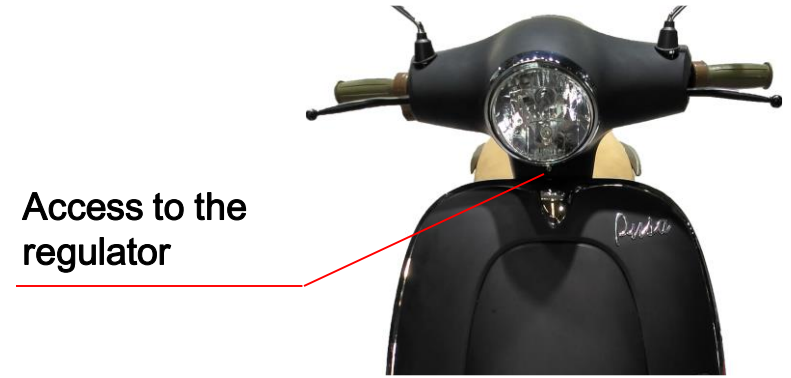

Access to the regulator

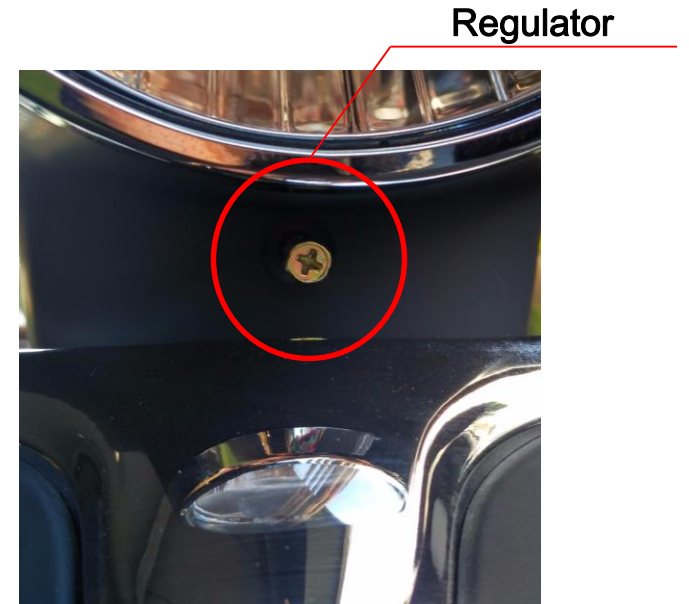

Regulator

# TECHNICAL SPECIFICATIONS

MOTOR	
Motor type	BLDC 12-3000
Motor location	Rear Wheel hub motor
Motor controller	Field Oriented Control (FOC) 150A max – 45A continuous
Torque (max/nominal)	120Nm / 50Nm
Power (max/continuous)	3.9 kW / 3 kW
Reverse mode	Yes

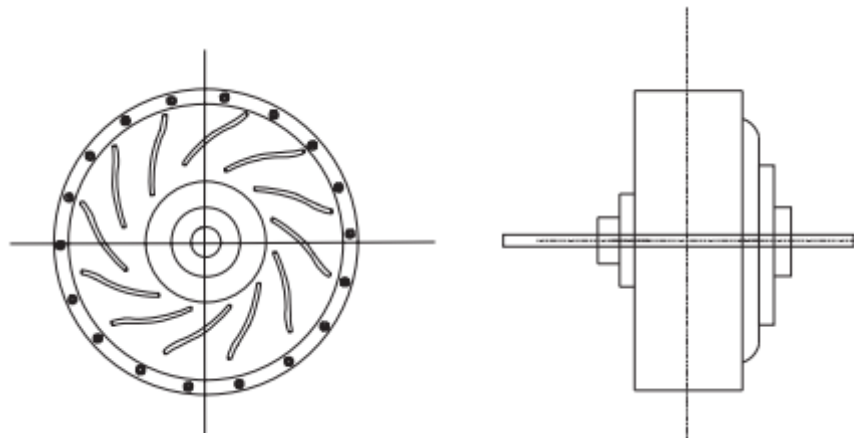

BATERÍA	
Battery type	Li-ion NMC
Nominal voltaje	72 V
Max voltaje	84 V
Nominal Capacity	25 Ah
Max / Nominal Energy	2,1 kWh / 1,8 kWh
Charger type	220V 50Hz AC-DC converter
Charger max power	300 W (84V max – 4A)
Charging time 0-80%	5h
Charging time 0-100%	7h
Battery lifespan	1200 cycles to 80% capacity @ 100% DoD



# TECHNICAL SPECIFICATIONS

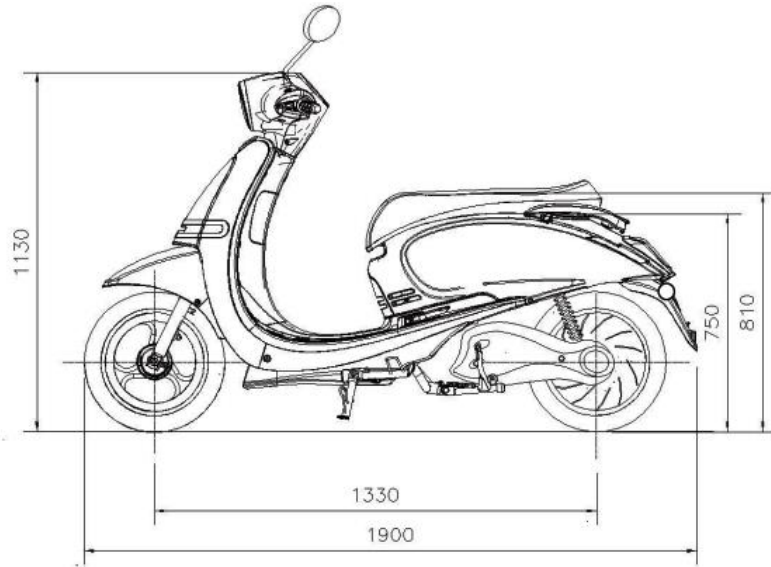

CYCLE PARTS / BRAKES	
Front Wheel	Aluminium rim 90/90-12
Rear Wheel	Hub motor 90/90-12
Front suspension	Telescopic fork
Rear suspension	Dual shock absorber
Front brake	Disc brake 180mm
Rear brake	Disc brake 220mm
Total length	1900mm
Seat height	810mm
Wheelbase	1330mm
Total height (no-mirrors)	1130mm

WEIGHT AND CARRYING CAPACITY	
Weight without battery	99 kg
Battery weight	12 kg
Total weight	111 kg
MMA	261 kg
Carrying capacity	150 kg

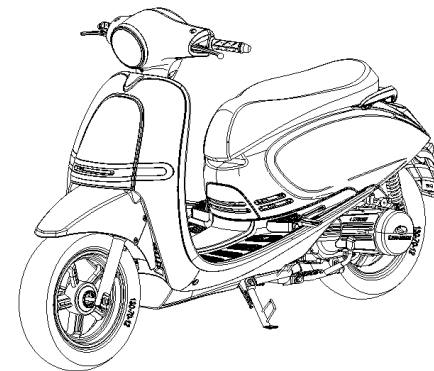

# GLOSSARY OF TERMS

Glossary of terms	
VIN	Identification number
CBS	Combined brake system
MMA	Maximum authorised mass
UE	European Union
PMSM	Permanent magnet synchronous motor
Li-ion	Lithium- ion
NMC	Nickel, Manganese, Cobalt
CC-CV	Constant Current – Constant Voltage
<i>Kill-switch</i>	Emergency general switch

Glossary of terms	
SoC	Status of charge
DoD	Depth of discharge
SoH	Status of Health
V	Voltage (Volts)
A	Current (Amps)
Ah	Relative Capacity (Amps/ hour)
kW	Power (Kw)
kWh	Energy (Kw / hour)
Nm	Torque (Newton/ meter)







**ERIDER**  
ELECTRIC VEHICLES

ERIDER  
Millesteenstraat 75, 8890 Dadizele  
[info@erider.be](mailto:info@erider.be)  
[www.erider.be](http://www.erider.be)